

Brushless DC Motor - 16 mm Ø

B16E32BZ000 109.7 Watts Peak Power

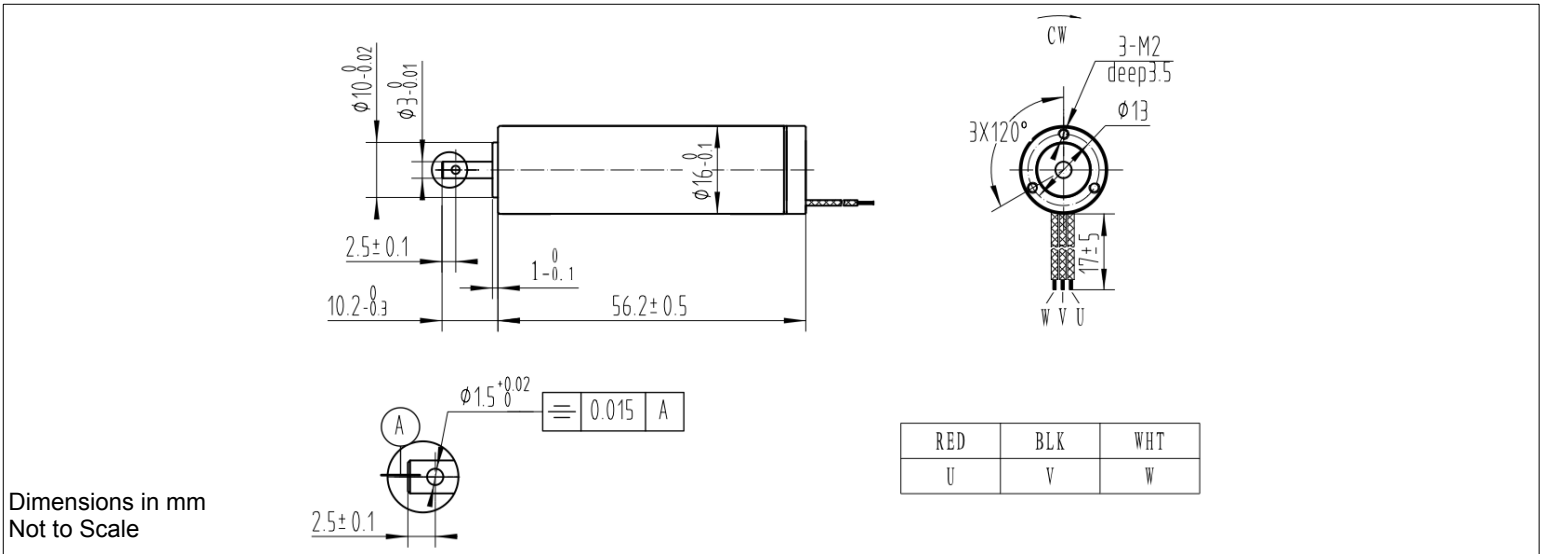

Global Motion Products



<i>Nominal voltage</i>	32.0 Volts
<i>No-load speed</i>	40,000 rpm
<i>Stall torque</i>	105.5 mNm
<i>No-load current</i>	0.100 Amps
<i>Peak Output power</i>	109.7 Watts

<i>Torque constant</i>	7.58 mNm/A
<i>Terminal resistance</i>	2.30 Ohms
<i>Back-EMF constant</i>	0.79 V/krpm
<i>Winding inductance</i>	0.110 mH

<i>Slope of speed/torque curve</i>	379.1 rpm/mNm
<i>Maximum Efficiency</i>	84 %
<i>Motor Constant</i>	5.00 mNm/Sqrt Watt

<i>Commutation Type</i>	Electronic - Sensorless
-------------------------	-------------------------

Radial Load Rating	24.0 N	Radial Play	0.015 mm	Max Temperature	85 °C
Radial Load Distance	7 mm	Thrust Play	0.200 mm	Min Temperature	-30 °C
Axial Load	24.00 N	Magnet Type	NdFeB	Max Winding Temp	125 °C
Press Fit Force - Max	60.00 N	Bearing Type	Ball Bearings	Mass	59 grams

Gearbox Options Contact GMP
 Encoder Options Contact GMP
 Options - Other Sensorless Version, Threaded Front and/or Rear Housing, Windings.

Global Motion Products

Distributed by:

Precision Motion Distributors: (925) 803-9565

Technical Support: (760) 451-2723

http://www.gmpwebsite.com Email: info@gmpwebsite.com

RoHS Compliant

A - January 2011

Specifications Subject to change without notice